

Setting Up Your Stand

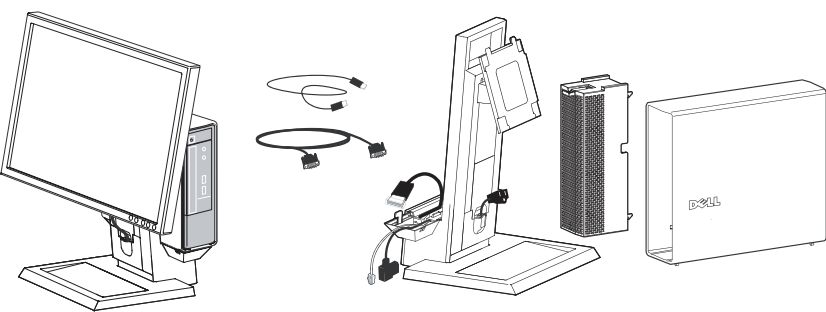

dell.com/regulatory_compliance

Dell™ OptiPlex™ 780-USFF All In One Stand

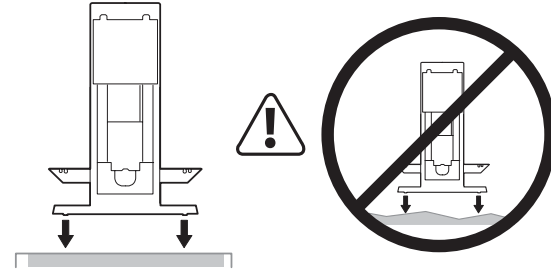

1 

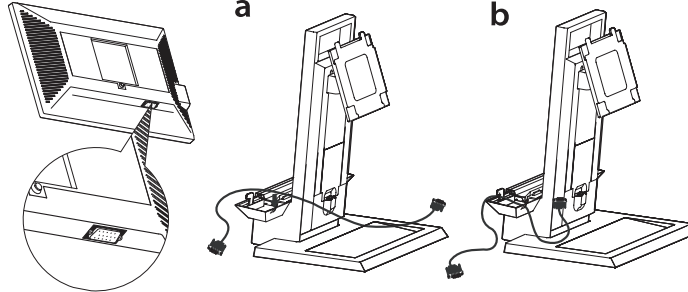
2 **VGA** 

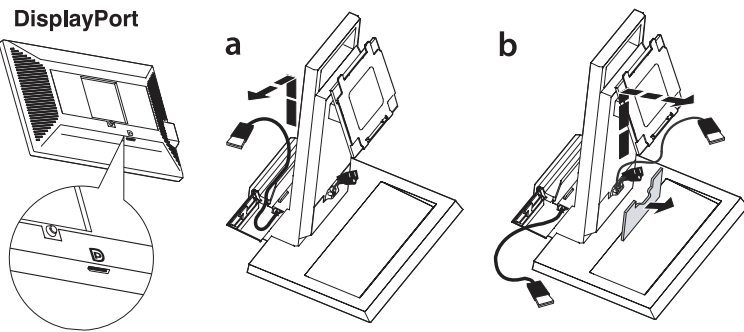
2 **DisplayPort** 

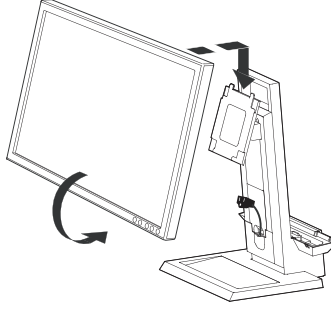
3 

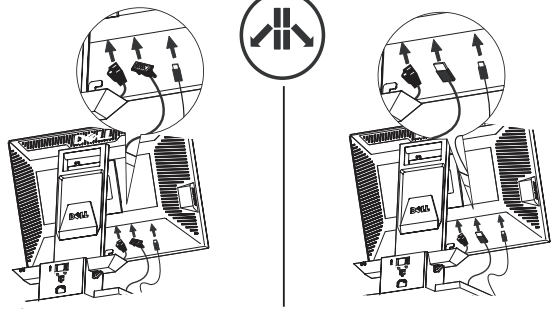
4 

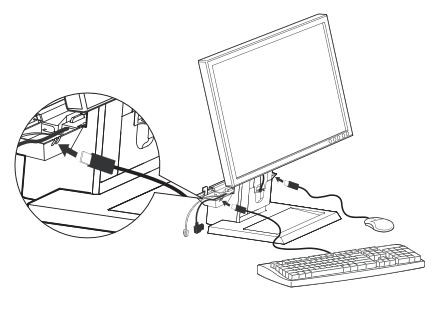
5 

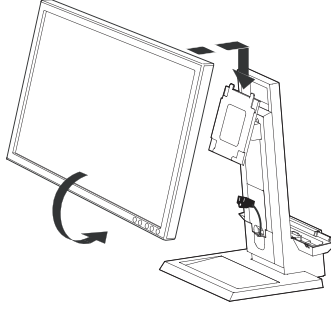
6 

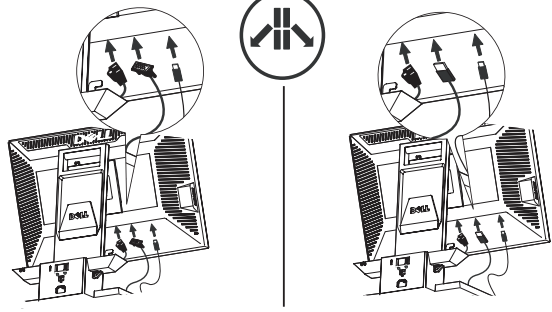
7 

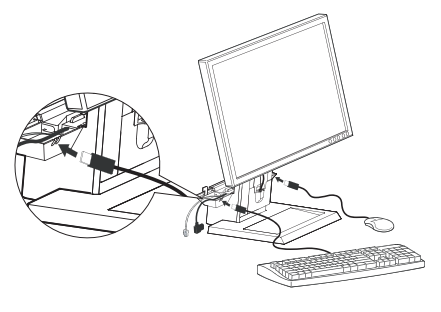
8 

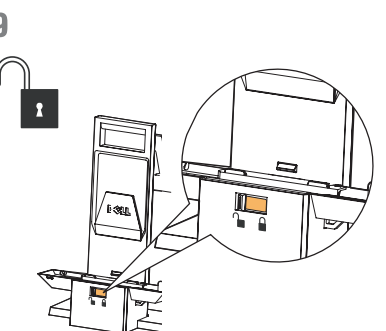
9 

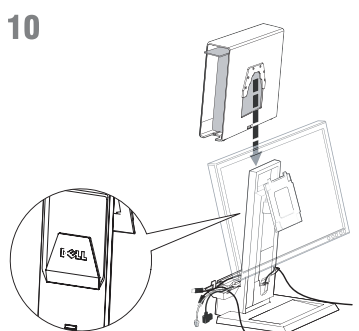
10 

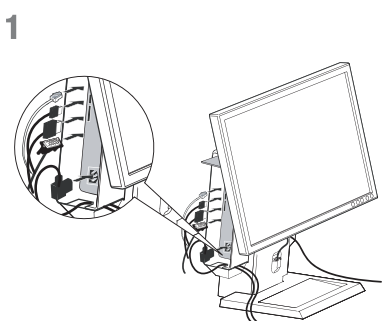
11 

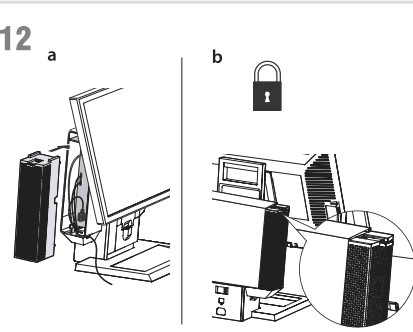
12 

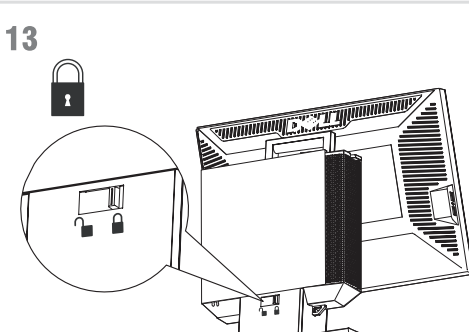
13 

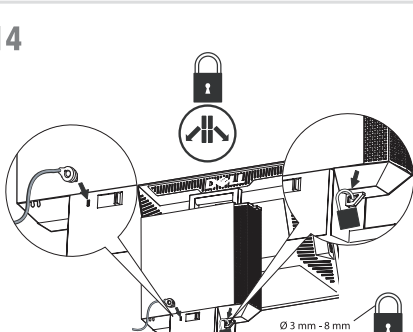
14 
Ø3 mm - 8 mm

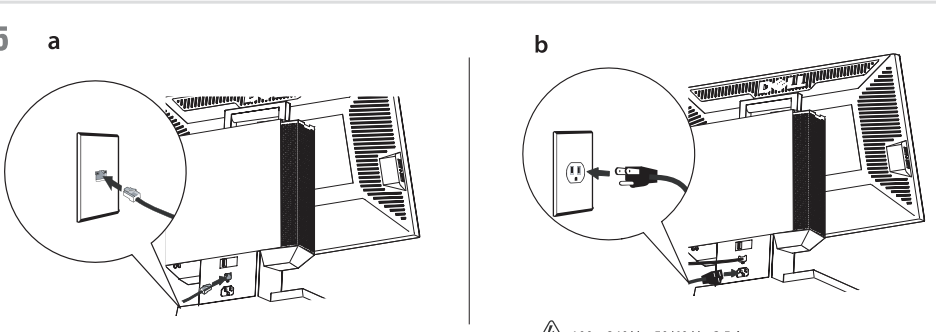
15 

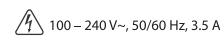
 100 – 240V~, 50/60 Hz, 3.5 A

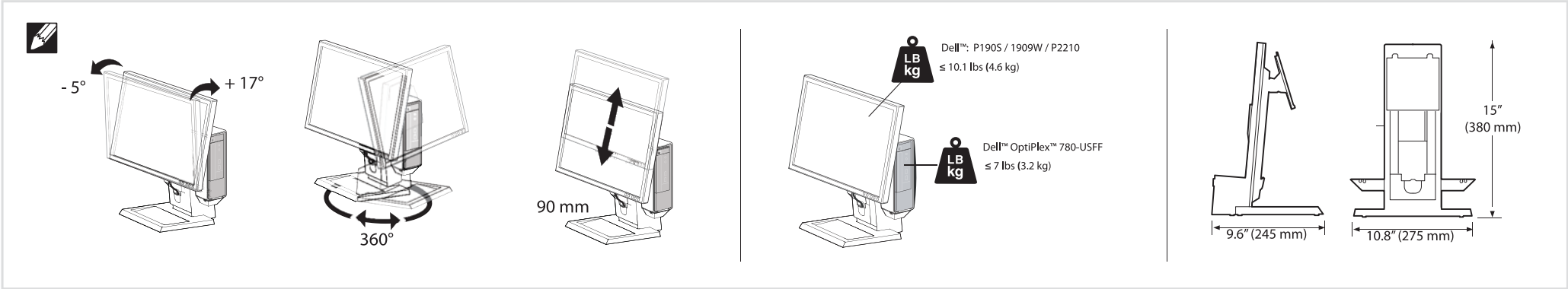

Information in this document is subject to change without notice.
© 2009 Dell™ Inc. All rights reserved.

Reproduction of these materials in any manner whatsoever without the written permission of Dell™ Inc. is strictly forbidden.

Trademarks used in this text:*Dell*, the *DELL* logo, and *OptiPlex* are trademarks of Dell Inc.

Other trademarks and trade names may be used in this document to refer to either the entities claiming the marks and names or their products. Dell™ Inc. disclaims any proprietary interest in trademarks and trade names other than its own.

Finding Information

If you need to	See:
Find safety best practices information for your computer, review Warranty information, Terms and Conditions (U.S. only), Safety instructions, Regulatory information, Ergonomics information, and End User Agreement	The safety and regulatory documents that shipped with your computer and the Regulatory Compliance Homepage at www.dell.com/regulatory_compliance.

Find safety best practices information for your computer, review Warranty information, Terms and Conditions (U.S. only), Safety instructions, Regulatory information, Ergonomics information, and End User Agreement

Find safety best practices information for your computer, review Warranty information, Terms and Conditions (U.S. only), Safety instructions, Regulatory information, Ergonomics information, and End User Agreement

Reproduktion dieser Materialien auf jegliche Art ohne die schriftliche Erlaubnis von Dell™ Inc. ist streng verboten.

In diesem Text verwendete Warenzeichen: *Dell*, das *DELL*-Logo und *OptiPlex* sind Warenzeichen von Dell Inc.

Andere Marken und Handelsnamen werden möglicherweise in diesem Dokument verwendet, um entweder auf die Rechtspersonen, die diese Marken und Namen beanspruchen, oder auf deren Produkte zu verweisen. Dell™ Inc. beansprucht keine Eigentumsrechte auf Marken und Handelsnamen mit der Ausnahme ihrer eigenen.

Auffinden von Informationen

In den folgenden Fällen:	Siehe:
Sie suchen nach Folgendem: Informationen zu den besten Sicherheitspraktiken, Informationen zur Garantie, Geschäftsbedingungen (nur USA), Sicherheitshinweise, regulative Informationen, ergonomische Informationen sowie Endbenutzerabkommen.	Die im Lieferumfang enthaltenen Handbücher sowie die Homepage mit Konformitätshinweisen unter:www.dell.com/regulatory_compliance

本指南的内容如有变更，恕不另行通知。
© 2009 Dell™ Inc. 版权所有。

未经 Dell™ 公司的书面许可，严禁以任何形式复制这些资料。

本文中所使用的商标： *Dell*、*DELL*标志和 *OptiPlex*都是Dell Inc.的商标。

本文档中还可能使用了其他的商标和公司名称，用以说明拥有这些标志和名称的公司或其产品。Dell™公司声明，对非本公司的商标和公司名称不拥有任何权利。

寻找信息

若您需要：	请参见：
寻找关于您计算机的安全性最佳实例信息、检阅保固信息、条款及条件（仅美国）、安全性指示说明、法规信息、人体工学信息，以及一般使用者合约。	您计算机所附的安全性及法规文件，该文件亦载于下列法规遵循首页：www.dell.com/regulatory_compliance。

Find safety best practices information for your computer, review Warranty information, Terms and Conditions (U.S. only), Safety instructions, Regulatory information, Ergonomics information, and End User Agreement

Informasi dalam dokumen ini bisa berubah tanpa pemberitahuan.**Hak cipta**
© 2009 Dell™ Inc. Semua hak cipta dilindungi undang-undang.

Dilarang keras mereproduksi semua materi ini dengan cara apa pun juga tanpa izin tertulis dari Dell™ Inc.

Merek-merek dagang yang digunakan dalam naskah ini: *Dell*, logo *DELL*, dan *OptiPlex* adalah merek dagang dari Dell Inc.

Merek dagang dan nama dagang lainnya mungkin digunakan dalam dokumen ini untuk mengacu pada entitas yang mengklaim merek dan nama atau mungkin produknya. Dell™ Inc. menafikan segala kepemilikan total atau sebagian merek dagang dan nama dagang selain miliknya sendiri.

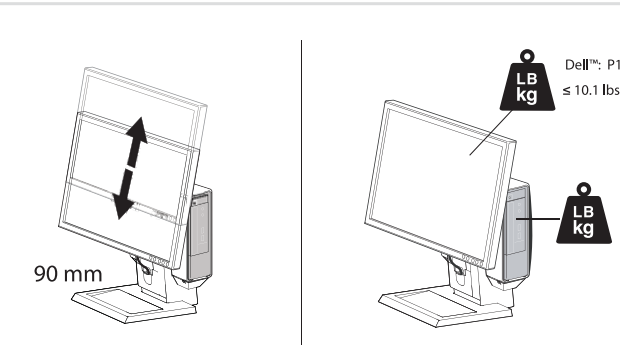

Find safety best practices information for your computer, review Warranty information, Terms and Conditions (U.S. only), Safety instructions, Regulatory information, Ergonomics information, and End User Agreement

Les informations contenues dans ce document peuvent être modifiées sans notification préalable.
© 2009 Dell™ Inc. Tous droits réservés.

Toute reproduction de ces documents strictement interdite, par quelque moyen que ce soit, sans autorisation écrite de Dell™ Inc.

Marques déposées utilisées dans ce texte: *Dell*, le logo de *DELL*, et *OptiPlex* sont des marques déposées de Dell Inc.

D'autres marques déposées et noms de sociétés peuvent être utilisés dans ce document pour faire référence au nom des sociétés les ayant déposés ou au nom de leurs produits. Dell™ Inc. dément toute prétention de propriété à l'égard de marques et des noms de sociétés autres que les siens.

Trouver des informations

Si vous avez besoin de :	Voir :
Trouver des informations sur les meilleures pratiques de sécurité pour votre ordinateur, revoir les informations de garantie, les termes et conditions générales (États-Unis seulement), les instructions de sécurité, les informations réglementaires, les informations sur l'ergonomie, et le contrat utilisateur final.	La sûreté et les documents de normalisation qui se sont transportés avec votre ordinateur et la page d'accueil de normalisation de conformité chez www.dell.com/regulatory_compliance.

Find safety best practices information for your computer, review Warranty information, Terms and Conditions (U.S. only), Safety instructions, Regulatory information, Ergonomics information, and End User Agreement

Le informazioni contenute in questo documento sono soggette a modifiche senza preavviso.
© 2009 Dell™ Inc. Tutti i diritti riservati.

È severamente vietata la riproduzione dei presenti materiali in qualsiasi modalità senza il permesso scritto di Dell™ Inc.

Marchi registrati utilizzati nel testo: *Dell*, il logo *DELL* e *OptiPlex* sono marchi commerciali della Dell Inc.

Altri marchi e nomi commerciali possono essere utilizzati in questo documento per fare riferimento alle entità titolari dei marchi e dei nomi o dei rispettivi prodotti. Dell™ Inc. esclude qualsiasi interesse di proprietà nei marchi e nei nomi commerciali non di sua proprietà.

Dove trovare le informazioni

Se stai cercando:	Vedi:
Informazioni sulle migliori misure di sicurezza del computer, informazioni sulla Garanzia, Termini e Condizioni (solo U.S. A.), istruzioni sulla sicurezza, informazioni sulle normative, informazioni sull'ergonomia e Contratto di licenza.	I documenti sulla sicurezza e sulle normative in dotazione al computer e la pagina Regulatory Compliance all'indirizzo www.dell.com/regulatory_compliance.

Find safety best practices information for your computer, review Warranty information, Terms and Conditions (U.S. only), Safety instructions, Regulatory information, Ergonomics information, and End User Agreement

本指南的内容如有变更，恕不另行通知。
© 2009 Dell™ Inc. 版权所有。

本文件在未獲 Dell™ Inc. 書面同意之前，嚴禁以任何方式複製這些內容。

本文內使用到的商標： *Dell*、*DELL*標誌和 *OptiPlex*都是Dell Inc.的商標。

本文件中可能會使用其他商標和商品名稱提及擁有該商標和名稱的實體或其產品。Dell™ Inc. 並無冒犯各商標及商品名稱所有人權益之意圖。

尋找資訊

若您需要：	請參見：
尋找關於您電腦的安全性最佳實例資訊、檢閱保固資訊、條款及條件（僅美國）、安全性指示說明、法規資訊、人體工學資訊，以及一般使用者合約。	您電腦所附的安全性及法規文件，該文件亦載於下列法規遵循首頁：www.dell.com/regulatory_compliance。

Find safety best practices information for your computer, review Warranty information, Terms and Conditions (U.S. only), Safety instructions, Regulatory information, Ergonomics information, and End User Agreement

Informasi Lainnya

Jika Anda ingin:	Lihat:
Menemukan informasi tentang penerapan keselamatan terbaik untuk komputer, lihat Informasi jaminan, Persyaratan dan Ketentuan (hanya di AS), Petunjuk keselamatan, Informasi peraturan, Informasi ergonomis, dan Perjanjian Pengguna Akhir.	Dokumen keselamatan dan peraturan yang diberikan bersama komputer ini serta situs Kepatuhan terhadap Peraturan di www.dell.com/regulatory_compliance.

Find safety best practices information for your computer, review Warranty information, Terms and Conditions (U.S. only), Safety instructions, Regulatory information, Ergonomics information, and End User Agreement

Informasi dalam dokumen ini bisa berubah tanpa pemberitahuan.**Hak cipta**
© 2009 Dell™ Inc. Semua hak cipta dilindungi undang-undang.

Dilarang keras mereproduksi semua materi ini dengan cara apa pun juga tanpa izin tertulis dari Dell™ Inc.

Merek-merek dagang yang digunakan dalam naskah ini: *Dell*, logo *DELL*, dan *OptiPlex* adalah merek dagang dari Dell Inc.

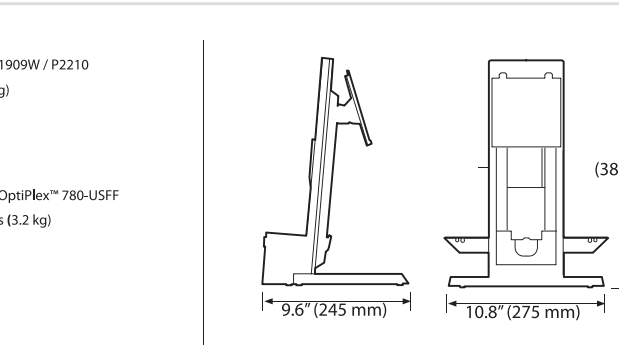

Find safety best practices information for your computer, review Warranty information, Terms and Conditions (U.S. only), Safety instructions, Regulatory information, Ergonomics information, and End User Agreement

La información de este documento está sujeta a cambios sin previo aviso.
© 2009 Dell™ Inc. Todos los derechos reservados.

Queda terminantemente prohibida cualquier reproducción de estos materiales sin el permiso escrito de Dell™ Inc.

Marcas comerciales utilizadas en este texto: *Dell*, el logotipo de *DELL* y *OptiPlex* son marcas comerciales de Dell Inc.

En este documento pueden aparecer otras marcas comerciales y nombres comerciales para referirse a las entidades que detentan las marcas y los nombres o a sus productos. Dell™ Inc. declina cualquier interés sobre la propiedad de las marcas comerciales y nombres comerciales que no sean los suyos propios.

Búsqueda de información

Si necesita:	Consulte:
Consultar información acerca de las mejores prácticas relacionadas con su equipo, acuda a la Información de garantía, la sección de Términos y condiciones (sólo EE. UU.), las Instrucciones de seguridad, la Información administrativa, la Información acerca de la ergonomía o el Contrato de usuario final.	Los documentos administrativos y de seguridad suministrados con su equipo, así como la página web de Conformidad administrativa a través de la dirección www.dell.com/regulatory_compliance.

Find safety best practices information for your computer, review Warranty information, Terms and Conditions (U.S. only), Safety instructions, Regulatory information, Ergonomics information, and End User Agreement

Informacje zawarte w niniejszym dokumencie mogą ulec zmianie bez uprzedzenia.
© 2009 Dell™ Computer Corporation. Wszystkie prawa zastrzeżone.

Powielanie niniejszych materiałów w jakiegokolwiek formie bez pisemnej zgody firmy Dell™ Inc. jest surowo zabronione.

Znaki towarowe używane w tekście: *Dell*, logo *DELL* oraz *OptiPlex* to znaki towarowe Dell Inc.

W niniejszym dokumencie mogą być stosowane znaki towarowe i nazwy firmowe w odniesieniu do firm lub produktów będących ich własnością. Dell™ Inc. nie posiada żadnych praw własności do innychnie h znaków towarowych i nazw firmowych poza własnymi.

Wyszukiwanie informacji

Jeśli chcesz:	Patrz:
znaleźć informacje na temat najlepszych praktyk bezpiecznej obsługi komputera, zapoznaj się z informacjami zawartymi w gwarancji, warunkami użytkowania (tylko USA), instrukcjami dotyczącymi bezpieczeństwa, informacjami o przepisach, informacjami o ergonomii oraz umową użytkownika końcowego.	dostarczone z komputerem dokumenty dotyczące bezpieczeństwa i zgodności z przepisami. Dodatkowo informacje można znaleźć w wityrnie zgodności z przepisami pod adresem www.dell.com/regulatory_compliance.

Find safety best practices information for your computer, review Warranty information, Terms and Conditions (U.S. only), Safety instructions, Regulatory information, Ergonomics information, and End User Agreement

本書に記載されている事項は事前通告なしに変更されることがあります。
© 2009 Dell™ Inc. 모든판권 소유.

Dell™ Inc. 의 서면 승인없이 이 문서를 복제하는 행위는 엄격히 금지됩니다.

이 텍스트에 사용된 상표: *Dell*과 *DELL* 로고, *OptiPlex*는 델(Dell Inc.)의 상표입니다.

기타 상표 및 상표명은 명명한 각 제품 표시 및 이름이나 각 제품을 나타내는 항목으로 이 문서에서 그대로 사용될 수 있습니다. Dell™ Inc. 은 Dell사가 아닌 상표 및 상표명에 대한 소유권을 인정하지 않습니다.

정보 찾기

만약:	다음을 참조하십시오:
컴퓨터에 대한 안전 모범 사례 정보를 찾고, 보증 정보, 약관 (미국만 해당), 안전 지침, 규제 정보, 인쇄 공학 정보, 최종 사용자 계약서를 검토해야 할 경우	컴퓨터에 부착된 안전 및 규제 문서와 규정 준수 홈페이지 www.dell.com/regulatory_compliance 를 방문하십시오.

Find safety best practices information for your computer, review Warranty information, Terms and Conditions (U.S. only), Safety instructions, Regulatory information, Ergonomics information, and End User Agreement

เนื้อหาของคู่มือการใช้เล่มนี้ อาจเปลี่ยนแปลง โดยไม่จำเป็นต้องแจ้งให้ทราบล่วงหน้า
© 2009 Dell™ Inc. สงวนลิขสิทธิ์

ห้ามทำซ้ำส่วนหนึ่งส่วนใดในเอกสารเหล่านี้ไม่ว่าในลักษณะใดๆ โดยไม่ได้รับการอนุญาตเป็นลายลักษณ์อักษรจาก Dell™ Inc. โดยเด็ดขาด

เครื่องหมายการค้าที่ใช้ในข้อความนี้: *Dell*, โลโก้ *DELL* และ *OptiPlex* เป็นเครื่องหมายการค้าของ Dell Inc.

ในเอกสารนี้อาจมีการใช้เครื่องหมายการค้าและชื่อทางการค้าอื่นๆ เพื่ออ้างถึงเครื่องหมายและชื่อหรือผลิตภัณฑ์ต่างๆ ของบริษัทอื่น Dell™ Inc. ขอยืนยันว่าบริษัทฯไม่มีผลประโยชน์ด้านกรรมสิทธิ์ในเครื่องหมายการค้าและชื่อทางการค้าอื่นใดนอกเหนือจากของทางบริษัทเอง

Find safety best practices information for your computer, review Warranty information, Terms and Conditions (U.S. only), Safety instructions, Regulatory information, Ergonomics information, and End User Agreement

Información para NOM (únicamente para México)
La información siguiente se proporciona en el dispositivo o dispositivos descritos en este documento, en cumplimiento con los requisitos de la Norma oficial mexicana (NOM):

Importador:			
Dell México S.A. de C.V. Pasco de la Reforma 2620 - 11° Piso Col. Lomas Altas 11950 México, D.F.			
Modelo	Voltaje de alimentación	Frecuencia	Consumo eléctrico
ARAI0	CA 100-240 V	50/60Hz	3,5A

Find safety best practices information for your computer, review Warranty information, Terms and Conditions (U.S. only), Safety instructions, Regulatory information, Ergonomics information, and End User Agreement

Информация данного документа может изменяться без предварительного уведомления.
© 2009 Dell™ Inc. Все права защищены

Воспроизводство данных материалов в любой форме без письменного разрешения Dell™ Inc. строго запрещено.

Товарные знаки, используемые в данном тексте: *Dell*, логотип *DELL* и *OptiPlex* являются товарными знаками Dell Inc.

Прочие товарные знаки и торговые марки могут использоваться в данном документе для отражения компаний, названия и марки продуктов которых здесь упоминаются. Dell™ Inc. не преследует любых интересов в отношении товарных знаком и торговых марок кроме собственных.

Поиск информации

Если необходимо:	См:
Найти установившиеся практики безопасности для компьютера, просмотреть информацию о гарантии, «Положения» (только США), «Инструкции по безопасности», «Нормативную информацию», «Информацию по эргономике» и «Соглашение с конечным пользователем».	См. документы по безопасности и нормам, которые прилагаются к компьютеру, а также домашнюю страницу «Соответствие нормам» на сайте www.dell.com/regulatory_compliance.

Find safety best practices information for your computer, review Warranty information, Terms and Conditions (U.S. only), Safety instructions, Regulatory information, Ergonomics information, and End User Agreement

As informações neste documento estão sujeitas a alterações sem aviso prévio.
© 2009 Dell™ Inc. Todos os direitos reservados.

A reprodução desses materiais por qualquer meio possível, sem permissão por escrito da Dell™ Inc, é estritamente proibida.

Marcas comerciais usadas neste texto: *Dell*, o logotipo *DELL* e o *OptiPlex* são marcas registradas da Dell Inc.

Outros nomes e marcas comerciais podem ser usados neste documento como referência a outros proprietários de nomes ou marcas ou a seus produtos. A Dell™ Inc. nega qualquer interesse de propriedade em marcas e nomes comerciais que não sejam seus.

Encontrando Informações

Se você precisa:	Veja:
Encontrar informações das melhores práticas de segurança para o seu computador, revise as Informações de Garantia, Termos e Condições (só para os EUA), Instruções de Segurança, Informações Regulamentares, Informações Ergonômicas e o Acordo do Usuário Final.	Os documentos de segurança e regulamentares que foram enviados com seu computador e a Página Inicial de Conformidade dos Regulamentos em www.dell.com/regulatory_compliance.

Find safety best practices information for your computer, review Warranty information, Terms and Conditions (U.S. only), Safety instructions, Regulatory information, Ergonomics information, and End User Agreement

本書に記載されている事項は事前通告なしに変更されることがあります。
© 2009 すべての著作権は Dell™Inc にあります。

Dell™ Inc. の書面による承諾書なしに本書を複製することは、いかなる方法といえども、固く禁止します。

本文における商標の使用： *Dell*、*DELL*ロゴ、*OptiPlex*はDell Inc.の商標です。

本書に引用される他の登録商標や商標名はその商標や商標名を有する企業もしくはは製品に所属します。Dell™ IncはDell Incに所属しない全ての登録商標及び商標名の所有権についてはこれを放棄します。

情報の検索

以下が必要な場合:	以下を参照:
コンピュータの安全なベストプラクティス情報を見つけ、保証情報、契約条件（米国のみ）、安全のしおり、規制情報、エルゴノミクス情報、エンドユーザー同意をレビューする。	コンピュータに付属の安全と規制マニュアル、および規制準拠のホームページ: www.dell.com/regulatory_compliance.

การค้นห่าข้อมูล

ถ้าคุณจำเป็นต้อง:	ดู:
ค้นหาข้อมูลหลักปฏิบัติเพื่อความปลอดภัยสำหรับคอมพิวเตอร์ของคุณ, ดูข้อมูลการรับประกัน, ข้อตกลงและเงื่อนไข (สหรัฐอเมริกาเท่านั้น), ขั้นตอนเพื่อความปลอดภัย, ข้อมูลเกี่ยวกับระเบียบข้อบังคับ, ข้อมูลเกี่ยวกับสิรราศาสตร์ และข้อตกลงการอนุญาตให้ใช้งานข้อมูล	เอกสารเกี่ยวกับความปลอดภัยและระเบียบข้อบังคับที่ส่งมาพร้อมกับคอมพิวเตอร์ของคุณและโฮมเพจความสอดคล้องกับระเบียบข้อบังคับที่ www.dell.com/regulatory_compliance